

HEAT PUMPS 2024/25

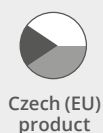

AIR-TO-WATER &
GROUND-TO-WATER

POWER RANGE
FROM 6 TO 50 KW





MasterTherm Online

Easy remote control of heat pump. Available not only for family houses, but also for apartment buildings, administrative, commercial or public buildings, and industrial applications.



Connection with photovoltaics



Smart grid ready



Management based on spot electricity prices



Interface for mobile, tablet, and desktop



24/7 online monitoring and remote service diagnostics



Dear customers and business partners,

on behalf of the entire Master Therm company, let me welcome you to the **brand new catalogue of heat pumps with R290 refrigerant.**

The recent turbulent years have brought new dynamics to the market. It wasn't just the rising energy prices, which caused a sharp increase in demand for heat pumps and put unprecedented pressure on manufacturers, supply chain and distribution partners. **These were and still are also legislative requirements.**

Heat pumps are closely affected by the gradual decline of synthetic refrigerants. They are replacing them with natural refrigerants. **The refrigerant that is to set the trend for the use in heat pumps is most likely to be R290, or pure, natural propane.**

Preparing "propane" pumps to meet the highest Master Therm standards in terms of performance, efficiency, reliability and safety, has presented one of the most demanding challenges in our 30-year history. After more than two years of development we are launching a new series of pumps accompanied with the letter P for propane: **air-to-water BoxAir Inverter P and ground-to-water AquaMaster Inverter P.**

Heat pump with new, natural refrigerant **gets even more of an approval stamp of a green heat source that will carry on setting the direction in the heating and cooling of buildings.**

Although a new era is starting with R290 refrigerant, pumps with current refrigerants (R410a, R407, etc.) have nothing to worry about. Whether they are already in operation or are yet to be installed, they will continue to serve reliably and we will provide them with full service support.

Finally, let me give thanks. And first of all to you, current and future customers. Thank you for already choosing a Master Therm heat pump or perhaps currently considering it as a heat source for your home or business. Thank you for trusting in our superior technology and quality. I hope we won't disappoint you and that maybe this catalogue will be of help to you in making your choice.

On behalf of Master Therm heat pumps, Ltd.

Ing. Karel Guzek
Export manager

MASTER THERM: A CZECH DEVELOPMENT AND MANUFACTURING TRADITION SINCE 1994

Master Therm heat pumps, Ltd., is a Czech manufacturer of air-to-water, ground-to-water and water-to-water heat pumps for family and apartment houses as well as industrial buildings. All technical development and production of Master Therm heat pumps takes place in the Czech Republic, EU. Master Therm exports more than two thirds of its production abroad, especially to Western Europe.

Table of contents

3
Introduction and contents

4-5
About heat pumps

6-7
Range of products

8
8 Reasons to choose Master Therm

9
Certificates

10-11
Advanced technologies

12
How to get a heat pump

13-20
Residential air-to-water: BoxAir Inverter P series

21-26
Residential ground-to-water: AquaMaster Inverter P series

27-34
Commercial air-to-water: BoxAir Inverter P for commercial and industrial buildings

Heat pump: questions and answers

What is the purpose of a heat pump?

A heat pump serves as an efficient energy source utilized for heating residential homes, commercial establishments, and industrial buildings. Beyond providing heating, it is also employed for generating hot water and cooling indoor spaces. By serving as a sustainable alternative to electric or gas boilers, heat pumps are recognized for their renewable energy credentials, operating without adverse environmental consequences.

Where does its high efficiency come from?

Compared to an electric or gas boiler, a heat pump is significantly more efficient because it also provides heat for your home or business from the surrounding environment: air, ground or water. The electric power of the heat pump only accounts for about 20–30% of the heat energy collected.

This is what yields key energy savings compared to those of a conventional electric or gas boiler. The efficient use of freely available energy from the environment multiplies the heating efficiency by up to 5.5 times (SCOP = 5.5) compared to an electric boiler. And your heating bills can be up to 80% lower.

What is the seasonal SCOP heating factor?

The heating capacity of a heat pump is much higher than the electric power input of a compressor, i.e. the efficiency of the pump is many times higher than 100%. The ratio of the heating power and the compressor input is called the COP.

The Seasonal Coefficient of Performance (SCOP) is a measure that quantifies the efficiency of a heat pump by comparing the total amount of heat produced to the total electricity consumption over an entire heating season. Depending on the specific kind and type of system being considered, SCOP values can range between 3.5 and 5.5, indicating higher levels of efficiency and performance in certain configurations.

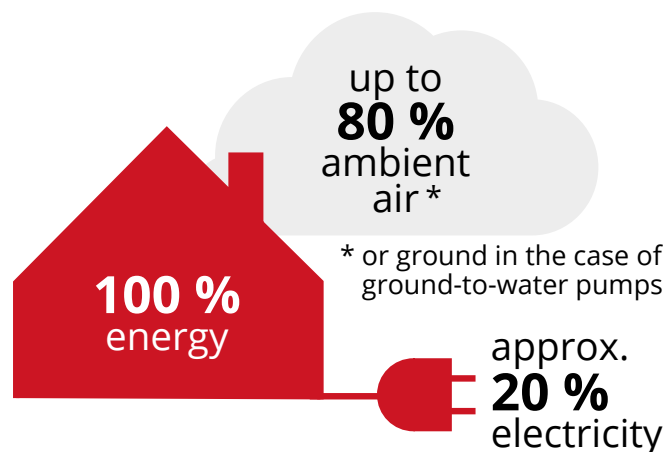

Achieve faster investment returns with government grant support:



Most of European countries offer a range of available grant supports. Inquire with your local distributor about the terms and conditions for subsidies. Master Therm heat pumps are registered and qualified for subsidies.

The heat pump can also cool thanks to the reverse mode.

During the summer months, it can provide long-term cooling of the building and thus significantly increases comfort during summer.





SYSTEMS OF HEAT PUMPS

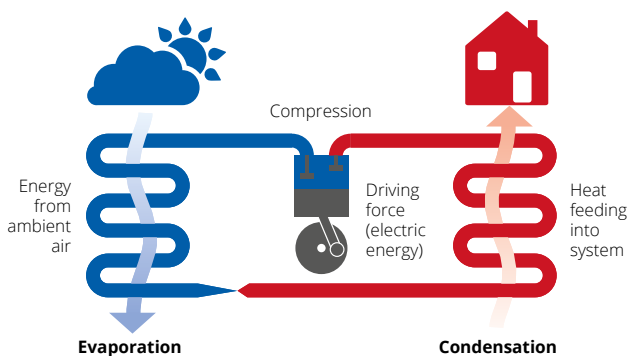

Air-to-water

Air-to-water heat pumps are based on the principle of extracting heat from the ambient air, whose temperature can be many degrees Celsius below zero. The heat extracted from the environment is transferred by the heat pump to the heating water that heats the building, or is used for the preparation of hot water. The system achieves a seasonal efficiency of up to 4.5 times higher than that of a conventional electric boiler and thus delivers significant energy savings.

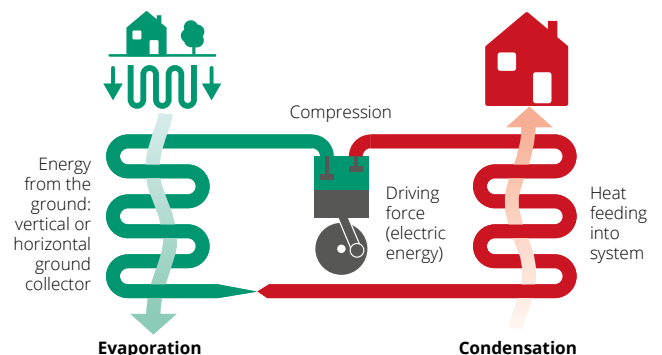

Ground-to-water

Ground-to-water heat pumps extract energy directly from the ground using a vertical or flat plate collector. An antifreeze mixture circulates through the collector and heats the ground. Thanks to the constant temperature of the ground, the heat pump has a stable source of energy throughout the year. The heat extracted from the ground is then transferred to the building. The system achieves a seasonal efficiency up to 5.5 times higher than that of a conventional electric boiler.

Model series: from 6 to 50 kW



BoxAir Inverter P

Residential air-to-water

BoxAir Inverter P is the latest range of air-to-water heat pumps. Thanks to the sophisticated design, the use of state-of-the-art components and R290 refrigerant this pump offers exceptional operating efficiency and a high outlet water temperature (up to 75 °C). It provides heat and hot water for a small passive new building, as well as an intergenerational family residence with thermal loss up to 18 kW. When connected to a cascade also suitable for apartment buildings and larger buildings.

KEY FEATURES

- **Power from 2 to 25 kW**
- Compact monobloc heat pump with built-in control, circulation pumps, etc.
- Energy efficiency A+++
- Extremely quiet operation
- Frequency controlled compressor with R290 refrigerant
- Integrated control system for up to 6 heating circuits
- Online control and monitoring
- Active cooling mode

AquaMaster Inverter P

Residential ground-to-water

By harnessing energy directly from the ground, AquaMaster Inverter P offers year-round high efficiency, exceptional reliability and long service life. Suitable for heating and cooling family houses with heat loss up to 6 kW, both for separate buildings with their own ground source, and for property complexes with shared ground collectors or boreholes.

KEY FEATURES

- **Power up to 6 kW**
- Extremely compact design
- Energy efficiency A+++
- Frequency controlled compressor with R290 refrigerant
- **Integrated 150 l storage tank for SHW (AquaMaster Inverter Combi P)**
- Independent of outside temperature or weather
- Integrated control system for up to 6 heating circuits
- Online control and monitoring
- Passive cooling



What does R290 refrigerant bring?

R290 or pure propane is a refrigerant with minimal impact on the environment (potential for global warming GWP = 3, potential ozone depletion = 0). Despite its purely natural origin, it has suitable thermodynamic properties for heat transfer. This is used by the R290 heat pumps to enable even greater-efficiency heating and higher-output temperature water (up to 75 °C).

Are there risks associated with R290?

None, as long as the pump is properly installed and positioned. Even so, our pumps come equipped with a leak sensor, automatic shutdown and check valves in the cooling circuit to avoid the slightest complication.

Provided compliance with basic measures is observed, which every one of our assembly partner does, heat pumps with R290 can be used safely for both outside (applies to air-to-water), as well as indoors (applies to ground-to-water pumps). The cooling circuit inside the pump is hermetically sealed and not interfered during assembly.

BoxAir Inverter P for commercial and industrial buildings

Commercial air-to-water

The most powerful air-to-water heat pumps in the Master Therm range. Designed for efficient and highly economical heating of residential buildings, commercial buildings, industrial buildings, schools, offices or sports facilities. Can be connected to a cascade of 100–1000 kW.

KEY FEATURES

- **Power up to 50 kW per compressor circuit**
- Compact design, easy installation, fast payback
- Total cascade power of more than 1000 kW
- Frequency-controlled compressor using R290 refrigerant
- MasterLAN power cascade control included
- Modbus RTU communication protocol
- Online control and monitoring
- Active cooling mode

Industrial projects Implemented

- Cooling of the CEZ Group Energo cogeneration units
- Cooling and heat recovery of the particle accelerator at the Institute of Nuclear Physics of the Czech Academy of Sciences
- Cooling and heat recovery of the national supercomputer at the IT4Innovations centre
- Cooling of diagnostic and surgical technologies at the Homolka Hospital in Prague
- Cooling and heat recovery of the production technology of The Candy Plus Sweet Factory
- ... and many more

8 reasons to choose Master Therm

1 A tradition since 1994



Master Therm was established in the Czech Republic in the 1990s, originally as an importer of heat pumps from the USA. Over years of gradual work on our own, we have become a manufacturer with a complete in-house development. All heat pumps from Master Therm are invented, designed and manufactured in the Czech Republic.

2 We offer a comprehensive and smart solution



With us you get a heating system, not just a separate heat source. We supply complete heat pump systems of all types, including **our own control software that can work with photovoltaics or automatically react to future spot electricity prices.**

3 Quality and innovation



Master Therm heat pumps are characterised by their efficient design, which ensures extremely quiet operation and trouble-free service access. We are among the pioneers in the development of electronic refrigerant injection (EEV), infinitely variable compressor power control (inverter) and software for controlling heating circuits.

4 Service and warranty



With a network of in-house technicians and immediate availability of spare parts, we guarantee nationwide service coverage. When you buy a heat pump, our journey together is just beginning. We offer online service monitoring of pumps and an extended warranty with unlimited coverage.

5 Reputation abroad



Master Therm exports more than 70% of its production abroad, especially to Western Europe. The most important foreign markets include the UK, Ireland, the Netherlands, Belgium, Italy, Switzerland, Estonia or Slovakia.

6 Awards and certificates



Our pumps are among the most appreciated, both at home and abroad. In addition to more than 20 international awards, we hold an ISO quality management certificate, Heat Pump Keymark certificate, certificates from the authorized testing laboratory ETI (SZÚ) in Brno, Czech Republic, EU, a certificate from the BBA of the United Kingdom and others.

7 Subsidies



In most countries heat pumps are registered in lists for subsidy titles. Ask your local distributor about terms and conditions of subsidies.

8 Local Presence



Master Therm Heat Pumps maintains a physical presence in United Kingdom, Ireland, the Netherlands, Belgium, Italy, Switzerland, Estonia or Slovakia. With services ranging from system design to spare parts availability, we provide peace of mind for all of our existing and prospective clients.



MASTER THERM HOLDS THE FOLLOWING CERTIFICATES:

European certification mark
The Heat Pump KEYMARK



Heat Pump KEYMARK

Quality Certificate for the Single European Market

The Heat Pump KEYMARK certificate is the European independent quality certificate for heat pumps entering the Single Market and covered by EU Regulations 813/2013 and 814/2013 – efficiency requirements (ecodesign).



Certificate of the testing institute Certificate of compliance with Czech and EU standards

Performance parameters and compliance of product characteristics with the requirements of the EN 14 511 standard. The Master Therm heat pumps are tested and certified by the accredited Engineering Testing Institute (SZÚ) in Brno, Czech Republic, EU.



BBA MCS Certificate

British quality certificate, allows to draw on British government incentives

Master Therm heat pumps are certified by the British Board of Agrément (BBA) according to the MCS (Microgeneration Certification Scheme) stand-ard, designed for systems for the production of heat and electricity from re-newable sources.

ISO 9001
BUREAU VERITAS
Certification



ISO 9001:2015 Certificate International Quality Certificate

Quality Management System Certificate in accordance with ISO 9001:2015. Scope of certification: manufacture, sale, installation and service of heat pumps. Certification body: BUREAUVERITAS GROUP.



Type conformity assessment protocol

Certificate confirming the characteristics of the products with the stated parameters

Certificate confirming that the type test has been successfully carried out on Master Therm products. It proves that the stated technical specifications of the products comply with the Czech and European Union standards.

We deliver and service all over Europe

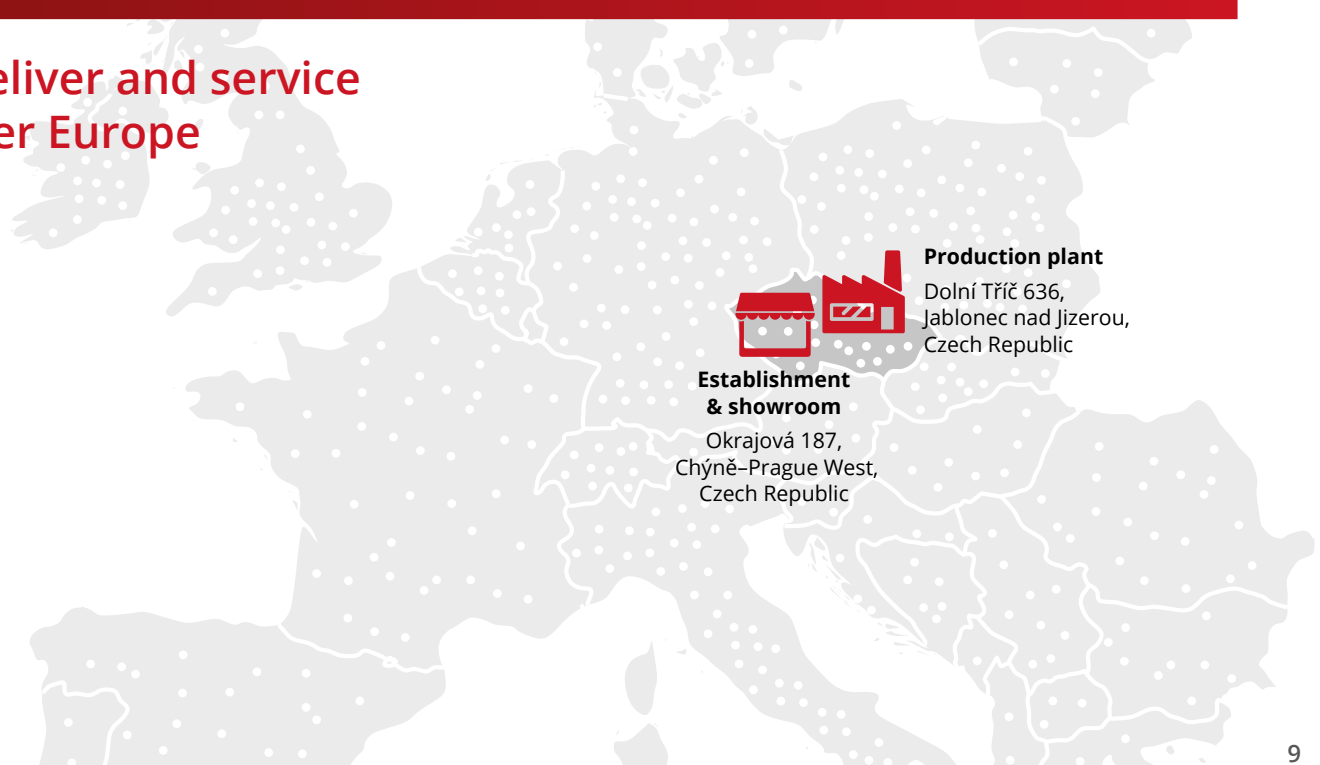

Production plant

Dolní Tříč 636,
Jablonec nad Jizerou,
Czech Republic

Establishment & showroom

Okrajová 187,
Chýně-Prague West,
Czech Republic

Advanced technologies

Master Therm Online

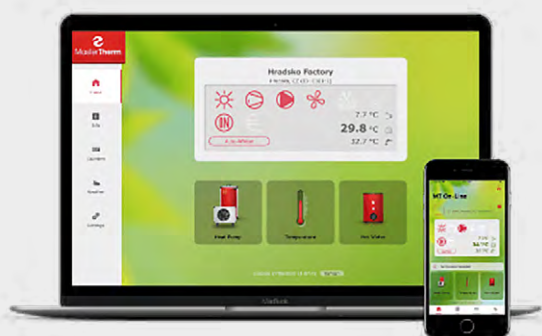

Connecting the Master Therm heat pump to the internet allows it **to be controlled from anywhere via the web browser on Mastertherm.online or via an app on a mobile phone or tablet.** You are thus in full control of your home's heat, which is within easy reach. Continuous service supervision and remote diagnostics included.

iOS app



Android app



Touchscreen display



The main control panel of the heat pump is the pGDx terminal, featuring a 4.3-inch touchscreen for easy temperature setting and control. It allows for centralized management of multiple heating circuits, supports Smart Grid communication, and offers connectivity options like Ethernet or Wi-Fi for network integration. Automatic online updates ensure optimal performance.

It supports communication within Smart Grids for efficient management of electricity production and consumption. Connection via Ethernet (cable) or Wi-Fi, automatic online updates.



Advanced control software



All MasterTherm heat pumps are equipped with a proprietary app that efficiently manages the cooling circuit and its peripherals. This system employs an equithermal approach that tracks external temperatures and incorporates sophisticated backward temperature control within the building using internal room sensors. Consequently, the heat pump is able to accurately sustain a consistent indoor temperature with exceptional precision, ensuring it never operates at a heating water temperature higher than required. Additionally, these heat pumps have the capability to seamlessly integrate with photovoltaic systems and automatically adjust to fluctuations in electricity spot prices for optimal efficiency.

Natural refrigerant R290



In the refrigeration compressor circuit, we employ the eco-friendly R290 refrigerant, known for its purity due to its natural propane composition. This refrigerant provides several advantages, including favourable thermodynamic properties that optimize the heat pump's efficiency and performance, leading to increased output water temperatures of up to 75°C. The system emphasizes safety by utilizing a hermetically-sealed containment method to prevent refrigerant leakage. Furthermore, additional safety measures such as a leakage detector, automatic unit shutdown system, and check valves within the cooling circuit are integrated to ensure maximum security and reliability.



Electronically controlled expansion valve (EEV)



Master Therm is one of the leaders in the use of electronic refrigerant injection technology. The EEV allows for precise control of the superheat temperature of the refrigerant vapour in the evaporator. This allows the evaporator area to be used with maximum effect for the evaporation of the refrigerant, resulting in higher plant efficiency. The EEV thus increases the heating factor, operational reliability and lifetime.

The EEV also protects the compressor against liquid injection at high loads. On the other hand, in the low-load mode (e.g., with a heating duct outlet temperature of less than 30°C), the electronic valve can be fully opened and a high-heating factor can be achieved, which is not possible with a thermostatic valve (TEV).

Heating in winter, cooling in summer



All Master Therm heat pumps can fully cool the building. By purchasing a pump, you are, therefore, also purchasing the perfect cooling solution for summer. Thanks to its design, it has approximately half the running costs of a conventional air conditioner. Additionally, even while in cooling mode, it can simultaneously heat hot water for domestic use.

For ground-to-water pumps, we offer **a passive cooling module that transfers heat from the interior to the ground collector without the need for a compressor.** This ensures extremely efficient summer cooling and contributes to the regeneration of the collector after the heating season.

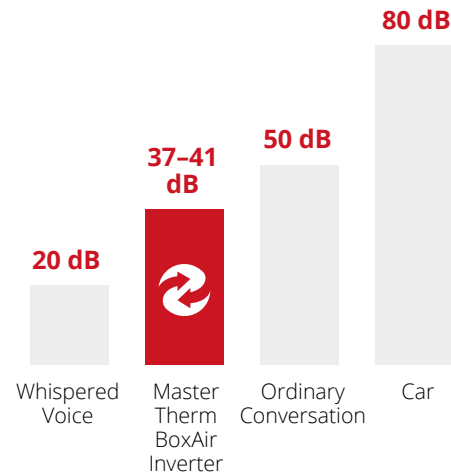

Quiet compressors and fans



All Master Therm heat pumps use quiet-scroll or double-rotary compressors, located in the unit in a special anti-vibration frame. Of course, the pump casing itself is carefully soundproofed.

For air-to-water heat pumps, we use the most modern low-speed fans with very low sound pressure levels, which ensure minimum noise levels in outdoor units

Frequency-controlled BLDC compressor



A compressor with a frequency converter (inverter) allows the heat pump continuously to regulate the heating / cooling capacity. The main advantages of inverter technology are electricity savings, more efficient use of heat exchangers, a reduction in the number of compressor starts, a reduction in the energy required to defrost the evaporator (air-to-water system), and as a result, an increase in the heating factor.

Thanks to the inverter, the pump does not require the installation of a storage tank, thus saving investment costs and space in the machine room.

HOW TO GET A MASTER THERM HEAT PUMP?

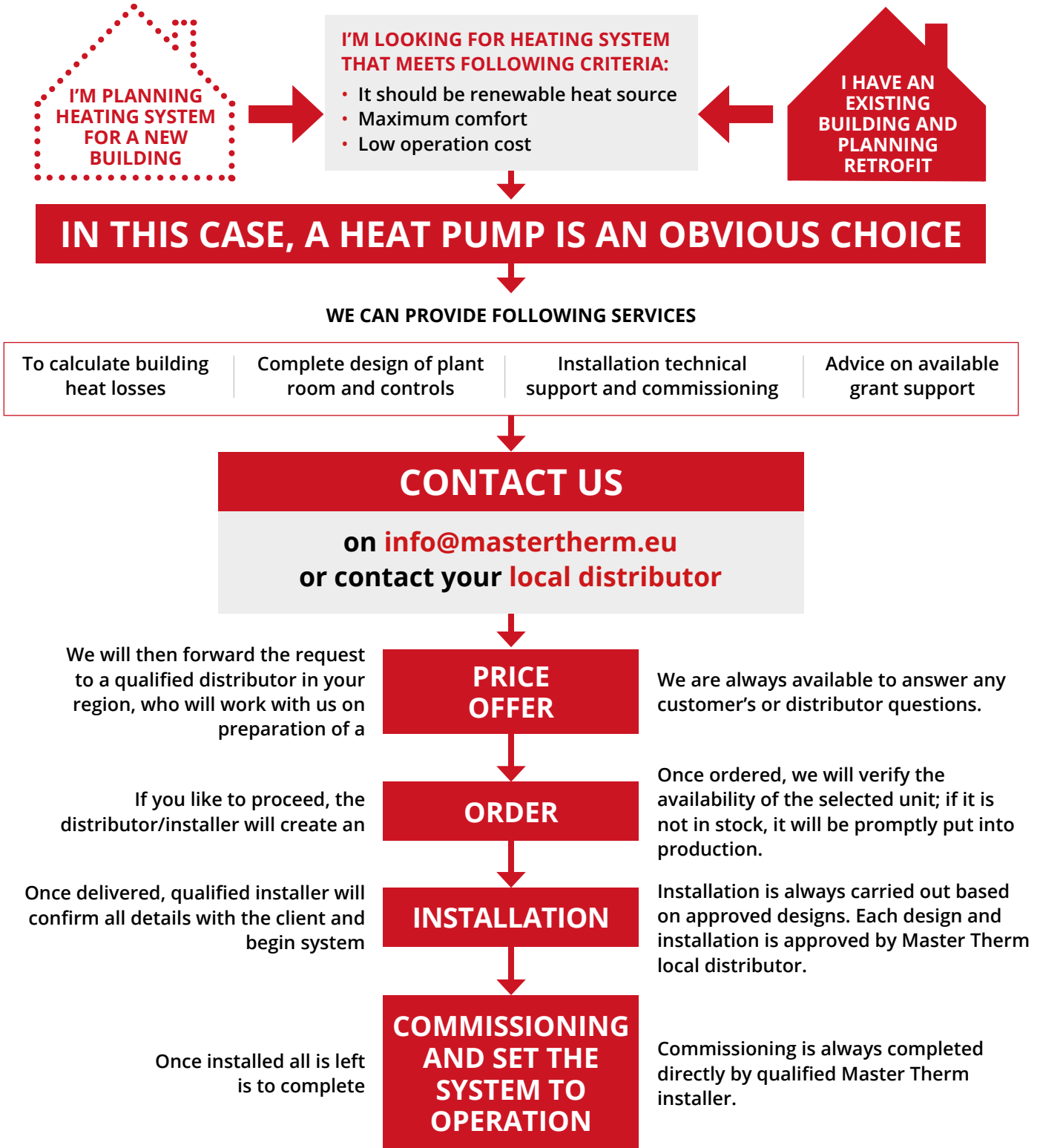

AFTER THE INSTALLATION, OUR JOURNEY TOGETHER BEGINS, MARKED FOR MANY YEARS TO COME BY YOUR HOME THERMAL COMFORT AND LOWER ENERGY BILLS.

AFTER THE FIRST AND EVERY SUBSEQUENT SEASON, WE'LL COME TO YOUR HOME FOR A PREVENTIVE SERVICE INSPECTION TO KEEP YOUR HEAT PUMP IN TOP SHAPE.

BoxAir Inverter P Series

Residential air-to-water



Czech (EU)
product



A tradition
since 1994



Exported into
30 countries
worldwide



Online
control

BoxAir Inverter P

BoxAir Inverter P is the latest heat pump range based on on natural refrigerant R290. This offers even more performance, efficiency and output water temperature up to 75 °C.

The BoxAir Inverter P provides heat and sanitary hot water for small passive new constructions as well as for an intergenerational family residences with a heat loss of up to 18 kW. In the summer months, it can also add as a cooling facility.

The BoxAir Inverter P is also suitable for apartment buildings and communal areas. When the need arises for higher heating capacity, several heat pumps can be connected in a cascade in succession.



**BoxAir
Inverter P**
All in one,
all outside

What does R290 refrigerant bring?

R290 or pure propane is a refrigerant with minimal impact on the environment (global warming potential GWP = 3, ozone depletion potential = 0). Despite its purely natural origin it has suitable thermodynamic properties for heat transfer. This is what R290 heat pumps successfully use to allow even higher heating efficiency and higher output temperature water (up to 75 °C). Safety is assured via a hermetically sealed cooling circuit, leak sensor, automatic pump shutdown and check valves in the circuit.



KEY FEATURES OF THE BoxAir Inverter P SERIES

- High efficiency and future-proofing with near-zero GWP refrigerant R290
- **Power from 2 to 25 kW**
- Extremely quiet operation according to current EU standards
- All internal components fully serviceable
- High reliability and easy maintenance
- Warranty and after-warranty service directly from the manufacturer
- Reverse cooling mode
- Integrated control system for up to 6 heating circuits
- Online control and monitoring





AIR-TO-WATER HEAT PUMPS

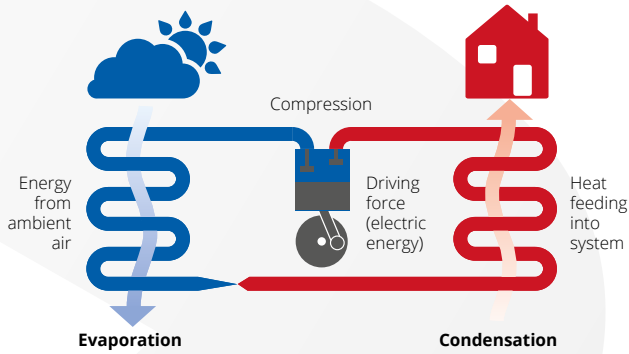

HOW THEY WORK

Air-to-water heat pumps are based on the principle of extracting heat from the ambient air, the temperature of which can be many degrees Celsius below zero. The heat extracted from the environment is transferred by the heat pump to the heating water that heats the building or is used in the preparation of hot water. **The system achieves seasonal efficiencies of up to 4.5 times higher than those of a conventional electric boiler and thus delivers significant energy savings.**



MAIN ADVANTAGES

The major advantages of air-to-water pumps include **relatively low investment costs, quick and easy installation and the easy availability of a primary energy source:** air is everywhere around us.



HEATS IN WINTER, COOLS IN SUMMER

Air-to-water heat pumps are suitable not only for heating and heating hot water or swimming pools all year round, but also for cooling the building in the summer months thanks to the possibility of reverse operation.



HEAT PUMPS AND SUBSIDIES

Heat pumps are recognised as a **renewable energy source**. Ask your local distributor if it is possible to obtain subsidies for them.

MASTER THERM: A CZECH MANUFACTURING TRADITION SINCE 1994

Master Therm is a manufacturer of air-to-water, ground-to-water and water-to-water heat pumps for residential, commercial and industrial buildings. All technical development and production of Master Therm heat pumps is carried out in the Czech Republic, EU.

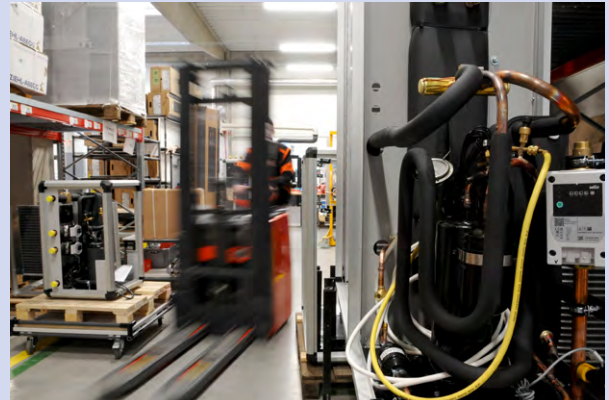

More than two-thirds of Master Therm's production are exported abroad, especially to Western Europe. Master Therm also carries out special projects such as heat recovery systems at the IT4Innovations supercomputer centre in Ostrava, Czech Republic, the cooling and recovery of waste heat from particle accelerators at the Institute of Nuclear Physics of the Czech Academy of Sciences or cooling and heat recovery of CEZ Group Energo cogeneration units.



BoxAir Inverter P

All in one, all outside

Extremely quiet and economical monobloc air-to-water heat pump with R290 refrigerant. Ideal for family houses with thermal loss of up to 18 kW.

Fans and evaporator

Ultra-quiet fans with smooth speed regulation and an evaporator with directed outflow of the condensate.

Total safety

Thanks to the low volume of the R290 refrigerant in the system, an integrated refrigerant leak detector, and automatic shutdown of the unit.



Frequency-controlled compressor with R290 refrigerant and electronically controlled expansion valve

Top technology increase efficiency (heating factor), operational reliability and long lifetime of the equipment. Included is also a built-in speed-controlled circulator pump.

Resilient all-aluminium cabinet

Aluminium construction of panels with a long-lasting resistance to weathering and corrosion. Default colour setting: anthracite RAL 7016.



A⁺⁺⁽⁺⁾ energy efficiency



top-notch design



online control



Unique Master Therm software for pump control

- Custom application for controlling the cooling circuit and peripherals
- Equithermal MaR (measurement and regulation) system
- Advanced **feedback control of building temperature** based on internal room temperature sensors
- Control via touchscreen terminal or online application
- Includes **remote service monitoring** and diagnostics
- Control of up to 6 heating circuits, including the possibility of connecting a pool or solar panel
- Cooperation with photovoltaics: **in-built connection to PV inverter**
- Smart tariff & Smart Grid: **automatic optimization of heat pump's operation based on future spot electricity prices**



SMART GRID READY



Model	Performance at A7W35	Thermal loss of the building Qz	Seasonal energy efficiency of heating at 35 °C low temperature operation		Seasonal energy efficiency of heating at 55 °C medium temperature operation		Maximum heating / SHW temperature	Order number (according to heating circuit control)	
	kW		SCOP	class	SCOP	class		regulation STANDARD (µPC)	regulation PLUS (pCO5)
 BoxAir 22 Inverter P	2-7	up to 5	4.85	A+++	3.76	A++	75	3-ph: BA22IP-301U 1-ph: BA22IP-101U	3-ph: BA22IP-311U 1-ph: BA22IP-111U
	BoxAir 26 Inverter P	4-14	up to 10	5.14	A+++	3.83	A+++	75	3-ph: BA26IP-301U 1-ph: BA26IP-101U
 BoxAir 37 Inverter P	6-20	up to 14	4.93	A+++	3.93	A+++	75	3-ph: BA37IP-301U 1-ph: BA37IP-101U	3-ph: BA37IP-311U 1-ph: BA37IP-111U
	BoxAir 45 Inverter P	8-25	up to 18	4.74	A+++	3.61	A++	75	3-ph: BA45IP-301U



The BoxAir 22IP and BoxAir 26IP models offer even more compact dimensions.

Designed for	single-circuit heating systems	multiple-circuit heating systems
Main heating circuit	yes	yes
Independent heating circuit	-	independently 2 incl. mixing
Space temperature	in 1 zone	in 2 zones
Hot water (SHW)	yes	yes
Selectable	-	up to 6 heating circuits

KEY FEATURES

- Compact monobloc outdoor thermal air-to-water pump
 - **Easy installation without intervention to the cooling (compressor) circuit and into the existing heating system**
 - Without indoor unit, all accessories including control and circulation pump integrated into the external unit
 - Full serviceability of all components
-
- Zero internal noise
 - **Minimised external noise due to ultra-quiet fans** with smooth rotation control
-
- Use for **heating and cooling of the building** including SHW preparation
 - Smart home integration: online 24/7 monitoring, modbus/BMS, integrated electricity meter, communication with PV inverter and batteries, connection to Smart Grids, etc.
 - Support for connection to a power cascade without the need to use a higher-level MaR (measure and regulation) third-party system
-
- **Heating water and SHW temperature up to 75 °C**
 - Anti-legionella function from compressor only
 - Outdoor temperature range from -20 °C to +40 °C
 - Integrated bivalent power supply as standard



Optional equipment

Master Therm Online App

Connecting the pump to a central Master Therm server allows the pump to be controlled online from anywhere via the web or app. Includes remote service access.

Full (active) cooling mode

Reverse pump operation allowing long-term cooling of the interior in summer.

Terminal pAD

Temperature compensation for independent heating circuit.

Terminal pADh (with humidity sensor)

Temperature compensation for independent heating circuit with dew point watching (floor cooling).

Expansion module for PLUS control

Increases the number of regulated independent heating circuits up to 6 (from the basic 2).

Integrated electric meter 3x 65 A / 1x 100 A

Built-in electric meter for local measurement of electricity consumption. MID certification.

RAL colour

Individual colour for pump panels.

Evaporator with corrosion resistant coating

Increased resistance for applications near the sea, etc.

BoxAir Inverter P



			BoxAir 22IP	BoxAir 26IP	BoxAir 37IP	BoxAir 45IP
Power range at A7W35		kW	2-7	4-14	6-20	8-25
Thermal loss of the building Q_z		kW	up to 5	up to 10	up to 14	up to 18
P-Design			4	7	11	14
Power A7W35 ¹	40 rps (if not defined otherwise)	kW	4.18 (60 rps)	5.55	9.66	11.44
	COP		5.01	5.18	5.10	4.73
Power A2W35	40 rps	kW	2.38	4.66	8.19	9.39
	COP		4.19	4.13	4.15	4.04
Power A-7W35	80 rps	kW	3.67	7.85	11.43	14.61
	COP		3.11	3.07	2.71	3.08
Power A-15W35	90 rps	kW	3.71	7.93	10.97	14.29
	COP		2.88	3.01	2.53	2.77
Power A7W55	60 rps	kW	4.18	5.55	9.66	11.44
	COP		5.01	5.18	5.10	4.73
Power A7W45	90 rps (if not defined otherwise)	kW	6.05	8.16 (60 rps)	18.15	16.75 (60 rps)
	COP		3.75	4.03	3.14	3.80
Power A-3W45	90 rps (if not defined otherwise)	kW	4.38	8.36 (80 rps)	13.68	18.15
	COP		2.79	2.76	2.39	2.81
Power A-3W55	90 rps (if not defined otherwise)	kW	4.19	8.19 (80 rps)	13.36	17.35
	COP		2.39	2.42	2.11	2.41
Seasonal heating energy efficiency at 35 °C low temperature operation	power ³	kW	4.04	6.57	11.50	14.96
	SCOP		4.85	5.14	4.93	4.74
	η_s	%	191	203	194	187
	class		A+++	A+++	A+++	A+++
Seasonal heating energy efficiency at 55 °C medium temperature operation	power ³	kW	3.63	6.22	10.85	13.62
	SCOP		3.76	3.83	3.93	3.61
	η_s	%	147	150	154	141
	class		A++	A+++	A+++	A++
Refrigerant			R290	R290	R290	R290
Electric circuit breaker ²			16 A"B"	20 A"B"	25 A"B"	32 A"B"
Compressor	connection		1x 230 V or 3x 400 V	1x 230 V or 3x 400 V	3x 400 V	3x 400 V
Weight		kg	120	130	165	165
Mandatory leakage checks according to EP 517/2014			no	no	no	no
Maximum heating water temperature		°C	75	75	75	75
Heating capacity of integrated electric boiler	bivalence mode	kW	4.5	4.5	7.5	7.5
	backup mode (and at temperatures below -20 °C)	kW	4.5 + 4.5	4.5 + 4.5	7.5 + 7.5	7.5 + 7.5
Acoustic performance L_w		dB(A)	50	53	55	60
Sound pressure level L_p at a distance from the outdoor unit	1 m	dB(A)	41	44	46	51
	5 m	dB(A)	29	32	34	39
	10 m	dB(A)	23	26	28	33

1 Performance data according to EN 14 511, in accordance with EHPA requirements for the award of the Q quality mark. A7W35 60 Hz - air 7 °C, water 35 °C, compressor frequency 60 Hz.

2 Recommended value of electrical protection 3x 400 V, incl. auxiliary integrated electric boiler. The 22IP, 26IP, 37IP and 45IP units can also be connected to a mains supply of 1x 230 V with a fuse of 40 A "B" (22I) or 50 A "B" (26I, 30I).

3 Design output at an outdoor temperature of -10 °C according to EN 14 825.

DIRECT CONNECTION OF HEAT PUMP TO HEATING SYSTEM AND HW (HEATING-WATER) TRANSFER MODE

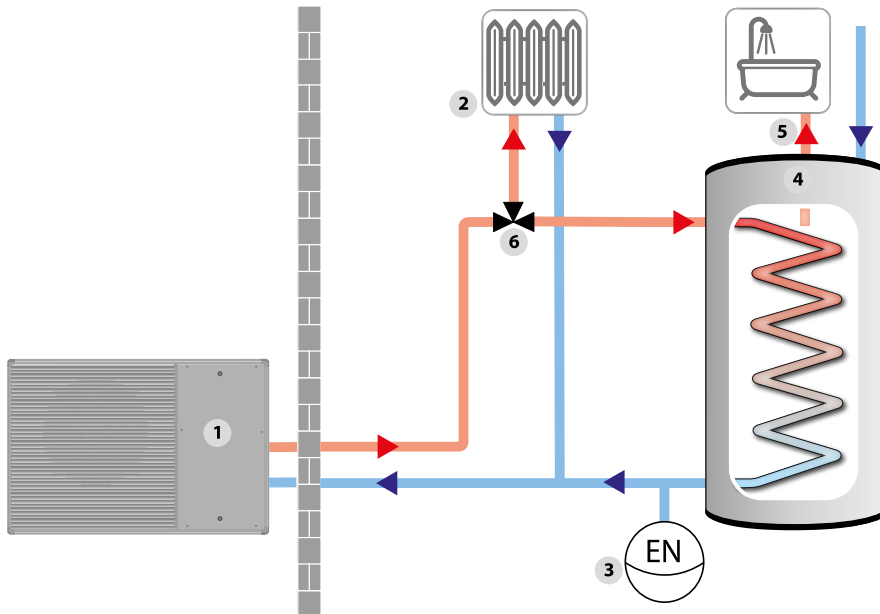

- 1 heat pump
- 2 heating system
- 3 expansion tank
- 4 HW indirect heating storage tank
- 5 HW outlet
- 6 3-way valve

The heat pump (1) is directly connected to the heating system. The heating water temperature varies depending on the outside temperature. When SHW heating is required, the space heating is switched off, and the 3-way valve (6) is switched on. By automatically increasing the heating water outlet temperature from the heat pump, the SHW storage tank (4) is heated. After set point is achieved, the system returns to space heating mode. The configuration is particularly suitable for underfloor heating, and also for systems with a sufficient volume of heating water.

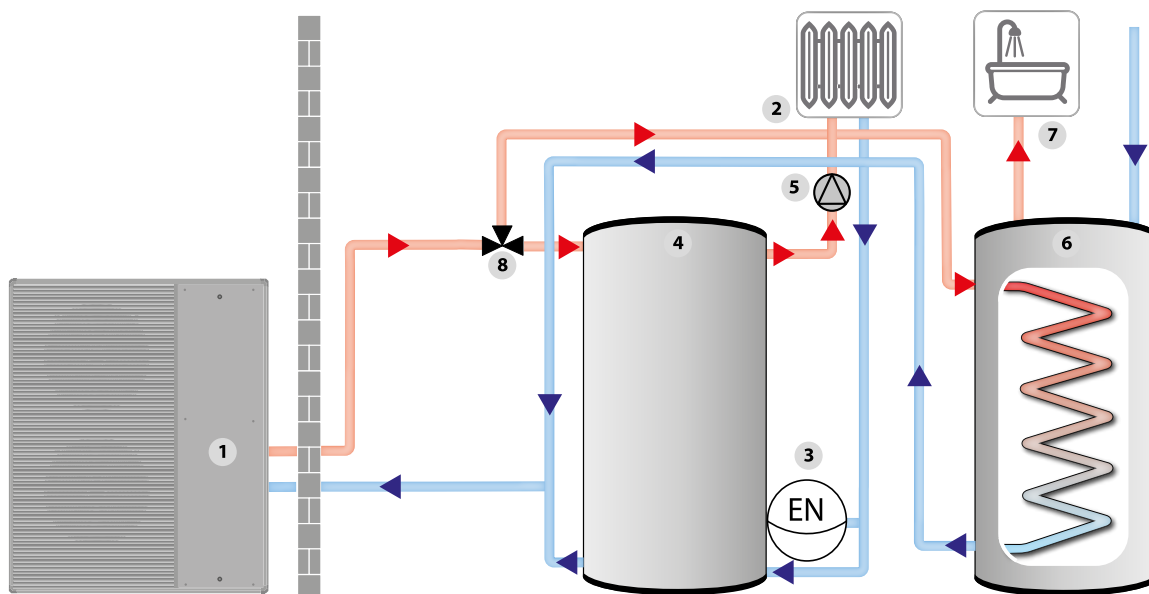

CONNECTION WITH HEATING WATER ACCUMULATION TANK AND HW HEATING TRANSFER MODE

- 1 heat pump
- 2 heating system
- 3 expansion tank
- 4 storage tank
- 5 heating system PC
- 6 HW indirect heating storage tank
- 7 HW outlet
- 8 3-way valve

The heat pump (1) is connected to the heating system via the storage tank (4), which acts as both heat storage and thermohydraulic distributor. The temperature of the heating water varies depending on the outside temperature. The flow of heating water through the heating system is provided by a circulating pump (5). When SHW heating is required, the space heating is switched off, and the 3-way valve (8) is switched on. By automatically increasing the heating water outlet temperature from the heat pump, the SHW storage tank (6) is heated. After set point is achieved, the system returns to space heating mode.

DIMENSIONS OF MODELS BA37IP AND BA45IP

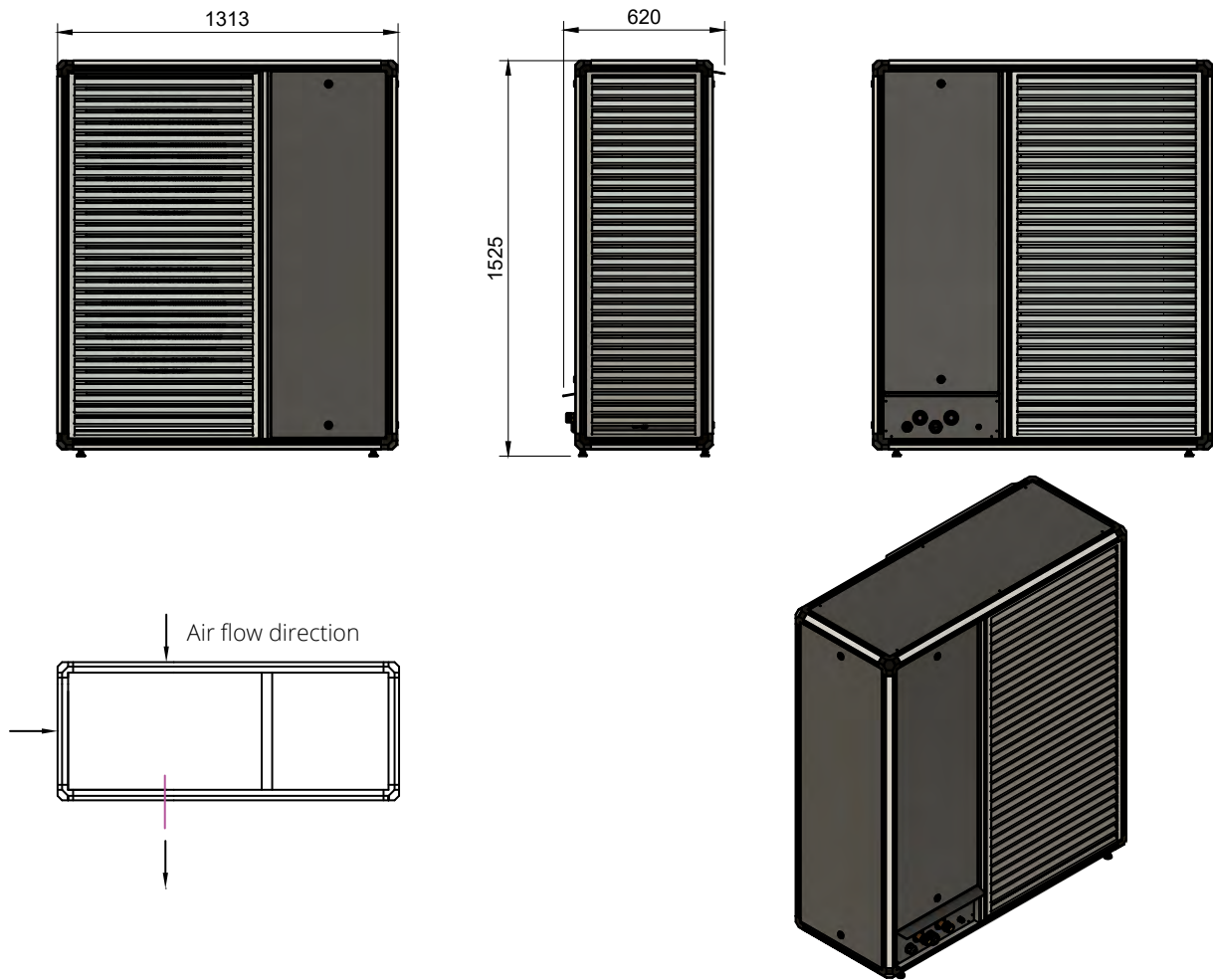

DIMENSIONS OF MODELS BA22IP AND BA26IP

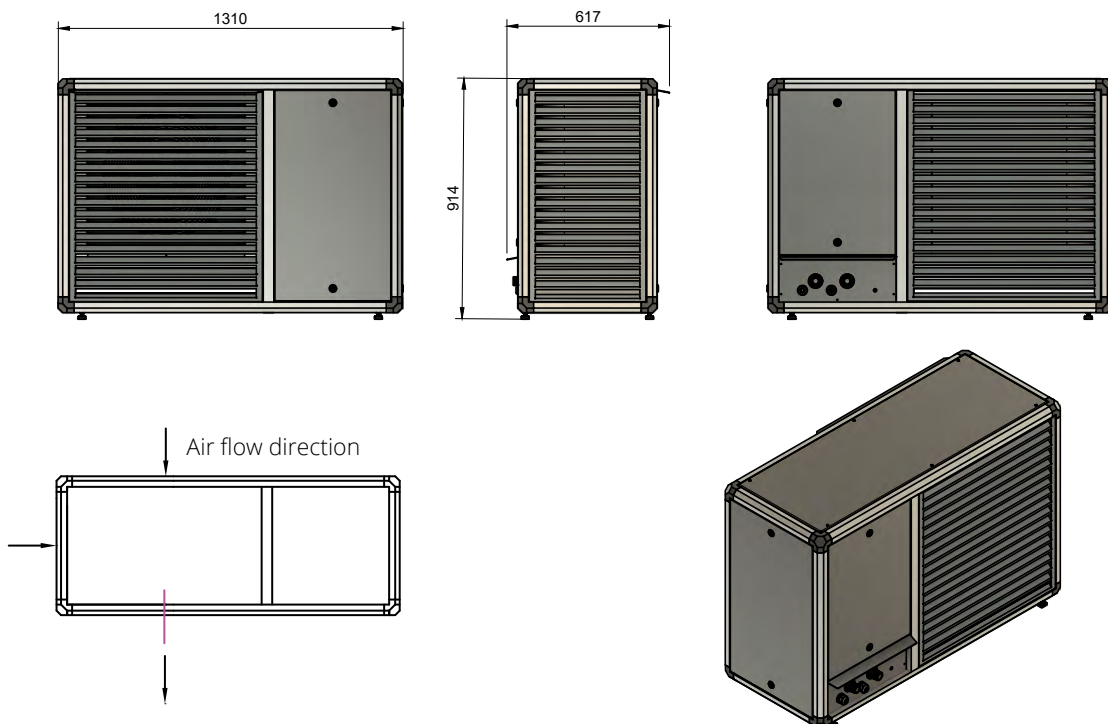

AquaMaster Inverter P Series

Residential ground-to-water

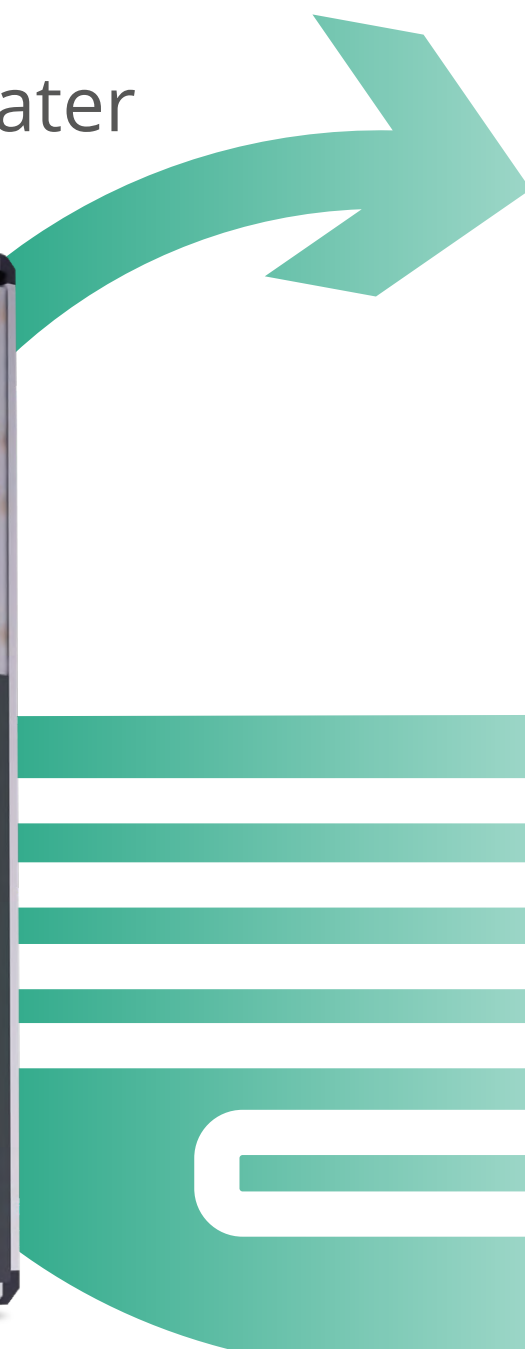

Czech (EU)
product



A tradition
since 1994



Exported into
30 countries
worldwide



Online
control

AquaMaster Inverter P

AquaMaster Inverter P is the latest range of heat pumps based on R290 natural refrigerant. It offers even higher performance, efficiency and outlet water temperature up to 75 °C.

By harnessing energy directly from the ground, the AquaMaster Inverter P is marked by a year-round best efficiency, exceptional reliability, and durability.

Suitable for heating and cooling of individual houses and complexes of properties with shared ground wells or horizontal collectors.



AquaMaster Inverter Combi P

With integrated SHW tank

What does R290 refrigerant bring?

R290 or pure propane is a refrigerant with minimal impact on the environment (global warming potential GWP = 3, ozone depletion potential = 0). Despite its purely natural origin it has suitable thermodynamic properties for heat transfer. This is what R290 heat pumps successfully use to allow even higher heating efficiency and higher output temperature water (up to 75 °C). Safety is assured via a hermetically sealed cooling circuit, leak sensor, automatic pump shutdown and check valves in the circuit.



KEY FEATURES OF THE AquaMaster Inverter P SERIES

- High efficiency and future-proofing with near-zero GWP refrigerant R290
- **Power up to 6 kW**
- Independent of outside temperature or weather
- All internal components fully serviceable
- High reliability and easy maintenance
- Warranty and after-warranty service directly from the manufacturer
- Passive cooling mode as optional
- Integrated control system for up to 6 heating circuits
- Online control and monitoring

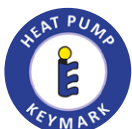



GROUND-TO-WATER HEAT PUMPS

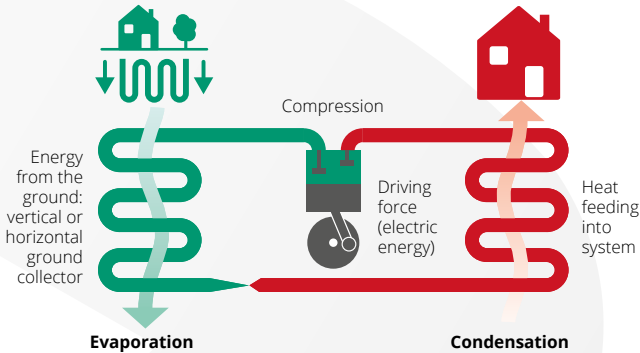

? HOW THEY WORK

Ground-to-water heat pumps extract energy from the ground by means of a vertical or horizontal collector**. Antifreeze circulates through the collector and removes ground heat. Thanks to the constant temperature of the ground, the heat pump has a stable source of energy throughout the year. The heat extracted from the ground is then transferred to the building. **The system achieves a seasonal efficiency up to 5.5 times higher than that of a conventional electric boiler.**

👍 MAIN ADVANTAGES

The ground-to-water system offers **stable heating performance throughout the year** and generally higher efficiency than air-to-water systems. The ground collector with a predicted lifetime of up to 100 years is an enduring investment in your building(s) and/or land(s).

🌿 HEATS IN WINTER, COOLS IN SUMMER

They are suitable not only for heating and year-round heating of hot water or swimming pools but also for highly efficient cooling of the building in summer thanks to the option of reverse or passive cooling.

€ HEAT PUMPS AND SUBSIDIES

Heat pumps are recognised as **a renewable energy source**. Ask your local distributor if it is possible to obtain subsidies for them.

**The depth of the vertical collector must be approximately 15-20 meters per 1 kW of building's heat loss. Land area for the horizontal collector is approximately 35-40 m² per 1 kW of a building's heat loss.

MASTER THERM: A CZECH MANUFACTURING TRADITION SINCE 1994

Master Therm is a manufacturer of air-to-water, ground-to-water and water-to-water heat pumps for residential, commercial and industrial buildings. All technical development and production of Master Therm heat pumps is carried out in the Czech Republic, EU.



More than two thirds of Master Therm's production is exported abroad, especially to Western Europe. For example, it has supplied 170 AquaMaster Inverter heat pumps for a development project in Cardiff, UK, where the pumps are connected to a system of 79 shared ground boreholes. Master Therm also implements special projects such as the system heat recovery in the supercomputer centre at IT4Innovations in Ostrava or reuse of heat within the ČEZ Energo units.



AquaMaster Inverter Combi P

With integrated SHW tank

Extremely compact, quiet and efficient ground-to-water heat pump with an output of up to 6 kW. Ready for low-carbon & sustainable properties.

All in one

Thanks to the compact design the unit occupies minimum space (only 0.3 m²). Available in both left and right configurations.

Total safety

With integrated refrigerant leak detector and automatic shut down of the unit. Thanks to minimum refrigerant volume inside the unit there is no need for ventilation.



Easy installation

Significant time- and cost-saving due to the "all-in-one" solution. A kit for a quick installation (expansion tank, pressure gauge, filter, fittings) also available.

Integrated stainless steel cylinder of 150 l

SHW temperature up to 65 °C. Anti-legionella function from compressor only. No backup heat required.

A⁺⁺⁺ energy efficiency



top-notch design



online control

Unique Master Therm software for pump control

- Custom application for controlling the cooling circuit and peripherals- Equithermal MaR (measurement and regulation)
- Advanced **temperature feedback control in the building** based on internal room temperature sensors
- Control via touchscreen terminal or **online application**
- Includes **remote service monitoring** and diagnostics
- Control of up to 6 heating circuits, including the possibility of connecting a swimming pool or solar panel
- Cooperation with photovoltaics: **in-built connection to PV inverter**
- Smart tariff & Smart Grid: **automatic optimization of heat pump's operation based on future spot electricity prices**



SMART GRID READY ✓



Model	Performance at B0W35	P-Design	Thermal loss of the building Qz	Seasonal energy efficiency of heating at 35 °C low temperature operation		Seasonal energy efficiency of heating at 55 °C medium temperature operation		Maximum heating / SHW temperature	Order number (according to heating circuit control)		
	kW	kW	kW	SCOP	class	SCOP	class		°C	regulation STANDARD (µPC)	regulation PLUS (pCO5)
AquaMaster 17 Inventer Combi P	1-6	4	up to 6	4.87	A+++	3.76	A++	75 / 65	1-ph / left: AQ17ICP-101L 1-ph / right: AQ17ICP-101R	1-ph / left: AQ17ICP-111L 1-ph / right: AQ17ICP-111R	
									Designed for	single-circuit heating systems	multiple-circuit heating systems
									Main heating circuit	yes	yes
									Independent heating circuit	-	independently 2 incl. mixing
									Space temperature	in 1 zone	in 2 zones
									Hot water (SHW)	yes	yes
									Optionally	-	up to 6 heating circuits

Optional equipment

Master Therm Online App

Connecting the pump to a central Master Therm server allows the pump to be controlled online from anywhere via the web or app. Includes remote service access.

Passive cooling module

Exclusive for ground-to-water pumps. Direct heat extraction from the interior of the ground collector or borehole. Extremely economical summer cooling of the building without the need for compressor work. Contributes to collector regeneration after the heating season.

External passive cooling module

Passive cooling in external casing.

Terminal pAD

Temperature compensation for independent heating circuit.

Terminal pADh (with humidity sensor)

Temperature compensation for independent heating circuit with dew point watching (floor cooling).

Expansion module for PLUS control

Increases the number of regulated independent heating circuits up to 6 (from the basic 2).

Integrated electric meter 1x 25 A

Built-in 1-phase electric meter for local measurement of electricity consumption. MID certification.

RAL colour

Individual colour for pump panels.

Left-side outlets and inlets

Outlets and inlets on the left side of the pump housing (on the right as standard).

KEY FEATURES

- Extremely compact ground-to-water heat pump
- Frequency-controlled compressor with R290 refrigerant
- **Integrated stainless-steel SHW tank with a volume of 150 l**
- Minimum space requirement (0.3 m²)
- Easy installation incl. quick installation kit
- Full serviceability of all components



- Indoor unit sound attenuated to the level of ordinary refrigerators



- Use for **heating and cooling of the building** including SHW preparation
- **Passive cooling module as optional**
- Smart home integration: connectivity to the Internet including 24/7 monitoring, modbus/ BMS, integrated MID electric meter
- **Communication with PV inverter and batteries**, connection into Smart Grids etc.
- Integrated circulation pumps for primary and secondary circuit incl. a 3-way valve
- Optional circulation pump on the side primary circuit with a 2-way zonal valve



- **Heating water temperature up to 75 °C**
- **SHW temperature up to 65 °C**



- Anti-legionella function from compressor only

AquaMaster Inverter Combi P



**AquaMaster
171CP**

Power range at B0W35		1-6
Thermal loss of the building Q_z	kW	up to 6
P-Design	kW	4
Power B0W35 ¹	60 rps	kW 3.87
	COP	4.29
Power W10W35	60 rps	kW 5.23
	COP	5.75
Power B0W55	60 rps	kW 3.50
	COP	2.97
Power W10W55	60 rps	kW 4.72
	COP	3.71
Power B5W35	60 rps	kW 4.51
	COP	4.96
Seasonal heating energy efficiency at 35 °C low temperature operation	power ³	kW 3.87
	SCOP	4.87
	η_s	% 187
	class	A+++
Seasonal heating energy efficiency at 55 °C medium temperature operation	power ³	kW 3.52
	SCOP	3.76
	η_s	% 143
	class	A++
Refrigerant		R290
Electric circuit breaker ²		1x 20 A"B"
Compressor	connection	1x 230 V
Weight / operational weight	kg	105 / 260
Maximum heating water temperature	°C	75
Maximum sanitary hot water temperature	°C	65
Approximate required length of ground well (or the sum of the length of several wells)	m	90

- 1 Performance data according to EN 14 511, B0W35 60 Hz – antifreezing mix 0 °C, water 35 °C, compressor frequency 60 Hz.
- 2 Recommended value of electrical protection in basic equipment, without auxiliary electric boiler.
- 3 Design output at outdoor temperature of -10 °C according to EN 14 825.

DIMENSIONS OF MODEL AQ171CP

- 1 heating water outlet – 5/4"
- 2 heating water inlet – 5/4"
- 3 evaporator inlet – 5/4"
- 4 evaporator outlet – 5/4"
- 5 electrical connection
- 6 SHW Inlet 1/2"ID
- 7 SHW Outlet 1/2"ID

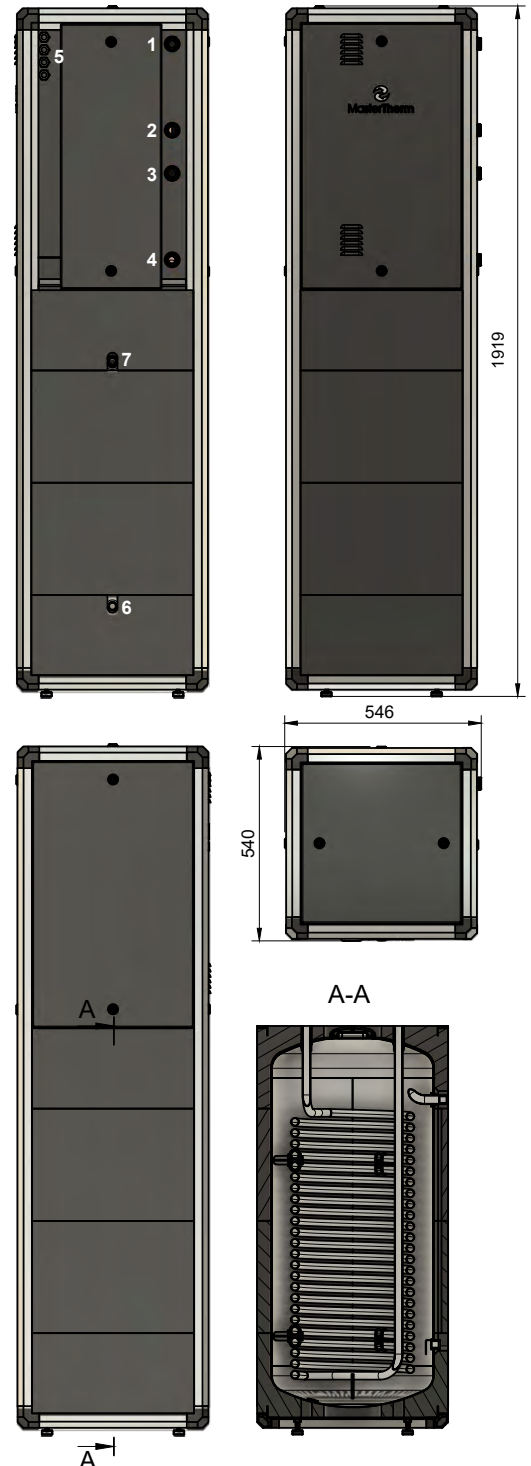

BoxAir Inverter P for commercial and industrial buildings

Air-to-water



Czech (EU)
product



A tradition
since 1994



Exported into
30 countries
worldwide



Online
control

BoxAir Inverter P

for commercial & industrial buildings

The most powerful air-to-water heat pumps in the Master Therm range. Up to 50 kW per compressor unit.

Designed for heating and cooling of residential, commercial and industrial buildings, schools, offices, or sports grounds.

Easily connectible to the cascade and ensure a very high overall power of 100–1000 kW for large buildings and industrial plants.



BoxAir 60 Inverter P

Compact monobloc (30 kW)



BoxAir 90 Inverter P

Compact monobloc (50 kW)

What does R290 refrigerant bring?

R290 or pure propane is a refrigerant with minimal impact on the environment (global warming potential GWP = 3, ozone depletion potential = 0). Despite its purely natural origin it has suitable thermodynamic properties for heat transfer. This is what R290 heat pumps successfully use to allow even higher heating efficiency and higher output temperature water (up to 75 °C). Safety is assured via a hermetically sealed cooling circuit, leak sensor, automatic pump shutdown and check valves in the circuit.



KEY FEATURES OF THE BOXAIR 60 / 90 Inverter P SERIES

- Power of up to 50 kW per compressor circuit
- Modbus RTU communication protocol
- MasterLAN power cascade control included
- Online control and monitoring
- Total cascade power of more than 1000 kW
- Active cooling as optional equipment



AIR-TO-WATER HEAT PUMPS

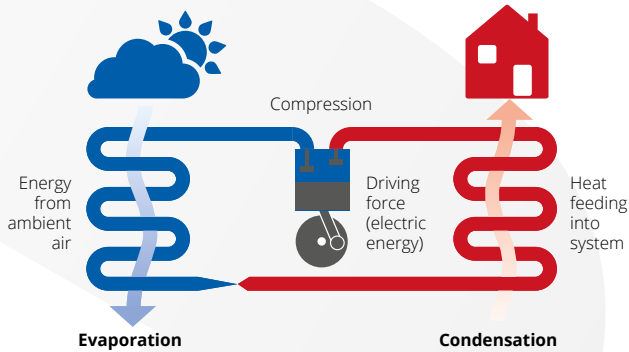

HOW THEY WORK

Air-to-water heat pumps are based on the principle of extracting heat from the ambient air, the temperature of which can be many degrees Celsius below zero. The heat extracted from the environment is transferred by the heat pump to the heating water that heats the building or is used in the preparation of hot water. **The system achieves seasonal efficiencies of up to 4.5.**

MAIN BENEFITS

The **high-end components** used and **the unique control system employed offer highly efficient and extremely quiet operation**, the ability to control up to 6 independent heating/cooling circuits and extended service life.

PROMPT RETURN ON INVESTMENT

An investment proven in practice: In the industrial facilities implemented so far, **the economic return is in the order of several years.**

HEATING AND COOLING

With a heat pump, a building or facility can be heated in winter and cooled in summer.

POWER CASCADE FOR HIGH PERFORMANCE

With the integrated MasterLAN software, **up to 16 heat pumps can be easily set up and connected to control power cascades.**

MASTER THERM: A CZECH MANUFACTURING SINCE 1994

Master Therm is a manufacturer of air-to-water, ground-to-water and water-to-water heat pumps for single-family residences and apartment buildings as well as industrial facilities. All technical development and production of MasterTherm heat pumps is carried out in the Czech Republic.



More than two thirds of Master Therm's production is exported abroad, especially to Western Europe. Master Therm also carries out special projects such as heat recovery systems at the IT4Innovations supercomputer centre in Ostrava, cooling and recovery of waste heat from particle accelerators at the Institute of Nuclear Physics of the Czech Academy of Sciences and cooling and heat recovery of ČEZ Energo cogeneration units.

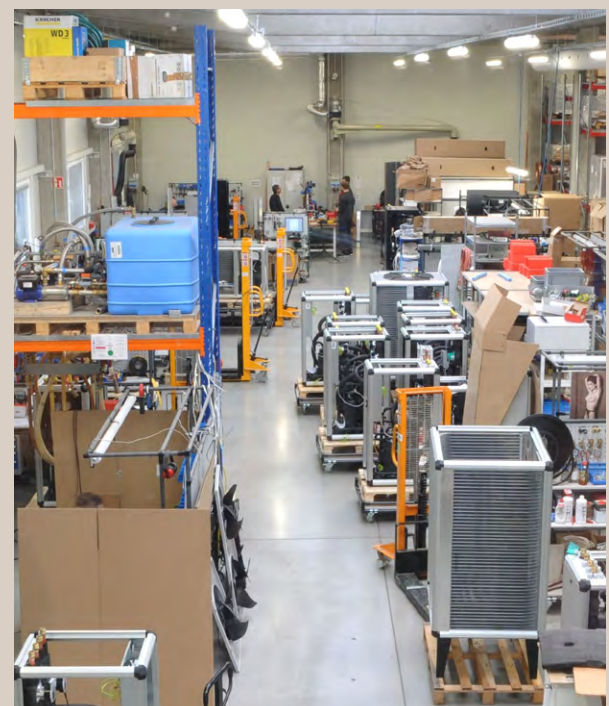

BoxAir 60 / 90 Inverter P

Compact monobloc

Highly efficient and environmentally friendly heat pumps for heating and cooling commercial & administrative buildings, production or storage halls, schools, sports facilities, and other larger facilities.

Refrigerant with minimum GWP

Maximally sustainable solutions with R290 refrigerant with the global warming potential = 3.

Absolutely safe

With integrated refrigerant leakage detector, automatic shut down of the unit, and check valves in the cooling circuit.



With high performance

BoxAir 90IP offers performance of 50 kW (A7W35), which makes it the most powerful air-to-water heat pump on our offer.

Handles temperatures up to 75 °C

Thanks to R290 refrigerant the outlet water temperature from the pump is up to 75 °C. Both for heating, as well as SHW.



BoxAir 60 Inverter P

Air-to-water unit with power of 30 kW is more compact in size



A⁺⁺⁺ Energy efficiency



top-notch design



online control

Unique Master Therm software for pump control

- Custom application for control of the cooling circuit and peripherals
- Equithermal MaR (measurement and control)
- Advanced **temperature feedback control in the building** based on indoor room temperature sensors
- Control via touchscreen terminal or **online application**
- Includes remote service monitoring and diagnostics
- Control of up to 6 heating circuits incl. optional solar connection
- Cooperation with photovoltaics: **in-built connection to PV inverter**
- Smart tariff & Smart Grid: **automatic optimization of heat pump's operation based on momentary electricity tariffs**





Model	Performance at A7W35	Thermal loss of the building Qz	Seasonal energy efficiency of heating at 35 °C low temperature operation		Seasonal energy efficiency of heating at 55 °C medium temperature operation		Maximum heating / SHW temperature	Order number (according to heating circuit control)
	kW	kW	SCOP	class	SCOP	class	°C	regulation PLUS (pCO5)
BoxAir 60 Inverter P	7-30	up to 25	4.89	A+++	3.73	A++	75	3-ph: BA60IP-311U
BoxAir 90 Inverter P	12-50	up to 40	4.68	A+++	3.55	A++	75	3-ph: BA90IP-311U

Designed for	multiple-circuit heating systems
Main heating circuit	yes
Independent heating circuit	independently 2 incl. mixing
Space temperature	in 2 zones
Hot water (SHW)	yes
Selectable	up to 6 heating circuits

KEY FEATURES

- Air-to-water system in a compact implementation
- Frequency-controlled compressor with R290 refrigerant
- **Power up to 50 kW per compressor circuit**
- Easy installation and connection to the building's heating system without the need for modifications
- **All internal components fully serviceable**
- No indoor unit
- MasterLAN power cascade control in basic equipment
- Modbus RTU communication protocol in basic equipment
- Built-in circulation pump with speed control



- Minimised noise due to ultra-quiet fans with infinitely variable speed control



- Smart grid integration: connectivity to the Internet incl. 24/7 monitoring, modbus/ BMS, integrated MID electricity meter, **communication with FV inverter and batteries**, connection to Smart Grids, etc.
- Use for heating and cooling of the building incl. hot water preparation
- Up to 16 pumps can be connected to power cascades



- Outdoor temperature range -20 °C to +40 °C
- **Heating water / SHW temperature up to 75 °C**
- Anti-legionella function from compressor only
- Possibility of managing collaboration with other, external heat sources
- Built-in bivalent power supply



Optional equipment

Master Therm Online App

Connecting the pump to a central Master Therm server allows the pump to be controlled online from anywhere via the web or app. Includes remote service access.

Full (active) cooling mode

Reverse pump operation allowing long-term cooling of the interior in summer.

Terminal pAD

Temperature compensation for independent heating circuit.

Terminal pADh (with humidity sensor)

Temperature compensation for independent heating circuit with dew point watching (floor cooling).

Expansion module for PLUS control

Increases the number of regulated independent heating circuits up to 6 (from the basic 2).

Expanded control module

For industrial/commercial applications.

Integrated electric meter 3x 65 A

Built-in 3-phase electric meter for local measurement of electricity consumption. MID certification.

RAL colour

Individual colour for pump panels.

Evaporator with corrosion resistant coating

Increased resistance for applications near the sea, etc.

BoxAir 60 / 90 Inverter P



			BoxAir 60IP	BoxAir 90IP
Power range at A7W35		kW	8-30	11-50
Thermal loss of the building Q_z		kW	up to 25	up to 40
P-Design		kW	21	31
Power A7W35 ¹	60 rps	kW	18.5	26.18
	COP		5.02	4.92
Power A2W35	60 rps	kW	14.34	20.60
	COP		4.08	3.99
Power A-7W35	90 rps	kW	17.56	24.81
	COP		3.17	2.95
Power A-15W35	120 rps	kW	21.29	30
	COP		2.25	2.56
Power A7W55	60 rps	kW	16.67	22.81
	COP		3.28	2.97
Power A7W45	120 rps (if not defined otherwise)	kW	27.83 (90 rps)	48.35
	COP		3.77	3.30
Power A-3W45	120 rps	kW	26.51	34.02
	COP		2.67	2.48
Power A-3W55	120 rps	kW	25.91	33.50
	COP		2.33	2.12
Seasonal energy efficiency heating – low-temperature operation at 35 °C	power ³	kW	21.54	29.4
	SCOP		4.89	4.68
	η_s	%	193	184
	class		A+++	A+++
Seasonal energy efficiency heating – medium-temperature operation at 55 °C	power ³	kW	20.28	29.14
	SCOP		3.73	3.55
	η_s	%	146	139
	class		A++	A++
Refrigerant			R290	R290
Electric circuit breaker ²			32 A"B"	40 A"B"
Compressor	connection		3x 400 V	3x 400 V
Weight		kg	275	350
Mandatory leakage checks according to EP 517/2014			yes	yes
Maximum heating water / SHW temperature		°C	75	75
Heating capacity of the integrated electroboiler	bivalence mode	kW	7.5	15
	backup mode (and at temperatures below -20 °C)	kW	7.5 + 7.5	15 + 15
Acoustic performance L_w		dB(A)	62	62
Sound pressure level L_p at distance from outdoor unit	1 m	dB(A)	53	53
	5 m	dB(A)	41	41
	10 m	dB(A)	35	35

1 Performance data according to EN 14 511, in accordance with EHPA requirements for the award of the Q quality mark. A7W35 60 Hz - air 7 °C, water 35 °C, compressor frequency 60 Hz.

2 Recommended electrical protection value 3x 400 V, incl. auxiliary integrated electric boiler.

3 Design output at outdoor temperature of -10 °C according to EN 14 825.

DIMENSIONS OF MODEL BA90IP

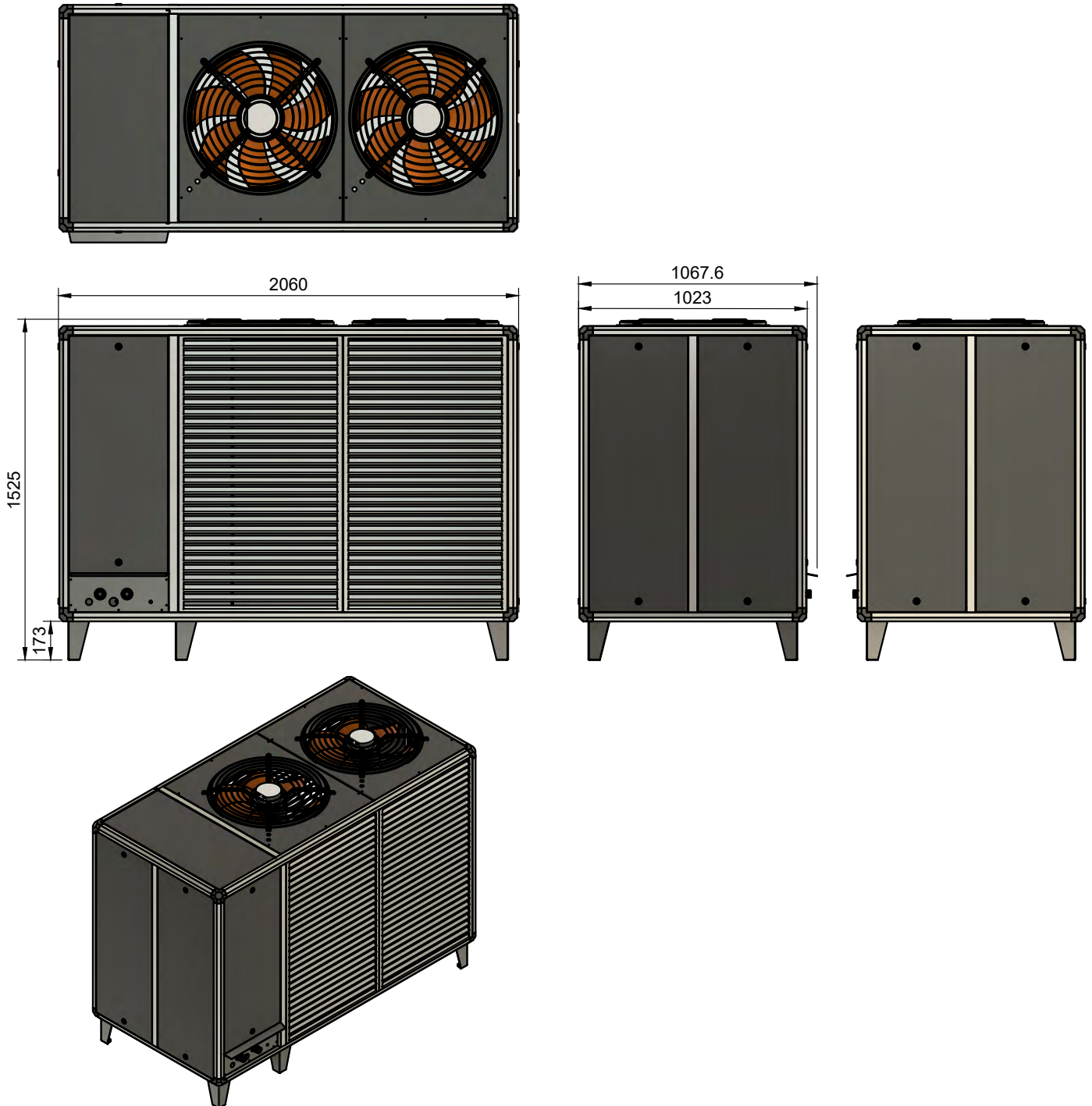

DIMENSIONS OF MODEL BA60IP





MasterTherm

THE PREMIER HEAT PUMP PIONEERS SINCE 1994



- 2024**
Complete range of heat pumps from 6 to 50 kW with natural refrigerant R290
- 2023**
New facility fully completed: production capacity of 3000 heat pumps per year
- 2022**
New production facility at Jablonec n. J.: 2000 heat pumps per year
- 2021**
Master Therm Online & pGDx: new level of control and online diagnostics
- 2018**
AQ ZHX: high-temperature heat pump for industry and heat recovery
- 2017**
BoxAir Inverter Split (air-to-water): split solution with compressor inside the inner unit
- 2016**
BoxAir 60 Inverter (air-to-water) with EVI: heating and cooling of commercial and industrial buildings
- 2010**
BoxAir Inverter (air-to-water): frequency-controlled compressor and fan
- 2008**
AquaMaster Inverter (ground-to-water): frequency-controlled compressor
- 2004**
AirMaster AKU (air-to-water): 1. heat pump with EEV on Czech market
- 1994**
Foundation of Master Therm brand



member of Atrea group



www.mastertherm.eu

Master Therm tepelná čerpadla, s. r. o.

ID number: 28892275
VAT: CZ28892275

Invoicing address

Václavské náměstí 819/43, 110 00 Praha 1,
Czech Republic, EU

Showroom and correspondence address

Okrajová 187, 253 01 Chýně,
Czech Republic, EU

Production plant

Dolní Tříč 636, 512 43 Jablonec nad Jizerou,
Czech Republic, EU

Contact

E-mail: info@mastertherm.cz
Telephone: +420 800 444 000

Service dispatch

E-mail: dispecink@mastertherm.cz
Telephone: +420 773 744 701